

# Data Sheet



Article number: 20329344

Description: E+G Handwheel  
GN 555-300-B26-A

## Measures

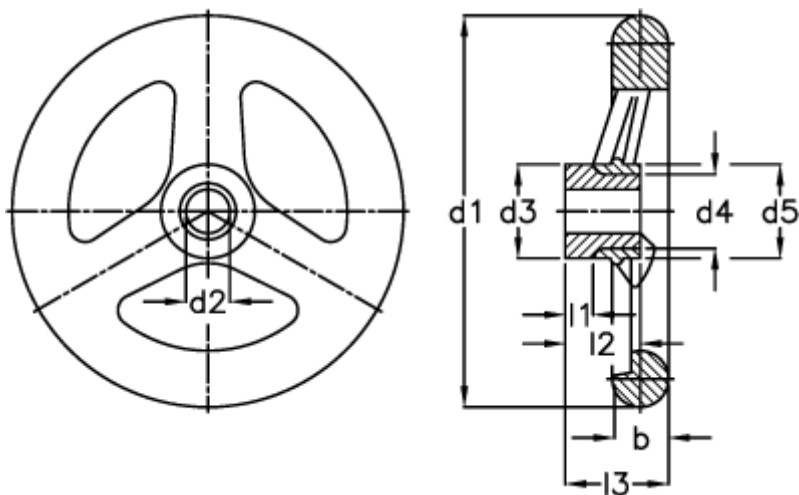

b	= 32	l2 -0.5	= 40
d1	= 300	l3	= 62
d2 H7	= 30	Number of spokes	= 3
d2 H7	= 26		
d3	= 58		
d4	= 47		
d5	= 70		
l1 -0.5	= 2		